



Birlea

Suppliers of inspiration

Assembly Instructions

Thank you for
purchasing a
Birlea product.

For a chance to win a *Love 2 Shop* voucher simply post a picture of your new product on your preferred social channels tagging Birlea Furniture and using the hashtag **#ShareYourStyle** and **#Birlea**. One winner will be selected at random each month.

To view our full terms and conditions please visit our website. www.birlea.com

Are you happy with your purchase?

Yes: That's great, we would love to hear more from you. Please leave us a review on our social media channels or Trustpilot. Your feedback will be greatly appreciated.

No: If for any reason there is something missing, indifferent or incorrect with your order, please contact the retailer you purchased the item from. We will work with the retailer to resolve your issue as quickly as possible.



www.birlea.com

ASSEMBLY INSTRUCTION

FAIRMONT OTTOMAN 4' BED

IMPORTANT: READ THIS INSTRUCTIONS CAREFULLY BEFORE ASSEMBLING OR USING YOUR FAIRMONT OTTOMAN 4' BED FRAME

PLEASE KEEP THESE INSTRUCTIONS FOR FUTURE REFERENCE.

HEALTH & SAFETY:

DO NOT jump on this bed frame.

DO NOT use this bed frame if any parts are missing,damaged or worn.

DO NOT use this bed frame unless all xings are secured.

Please keep small parts out of reach of children.

Always use on a level, even surface.

WARNING: If this bed is placed on a non-carpeted oor you must place some protection under all legs to stop the bed frame from moving. If this is not adhered to there is no guarantee if the bed frame collapses.

CARE & MAINTENANCE:

Assemble in the room of use.

Periodically check all screws & xings to ensure they are secure.







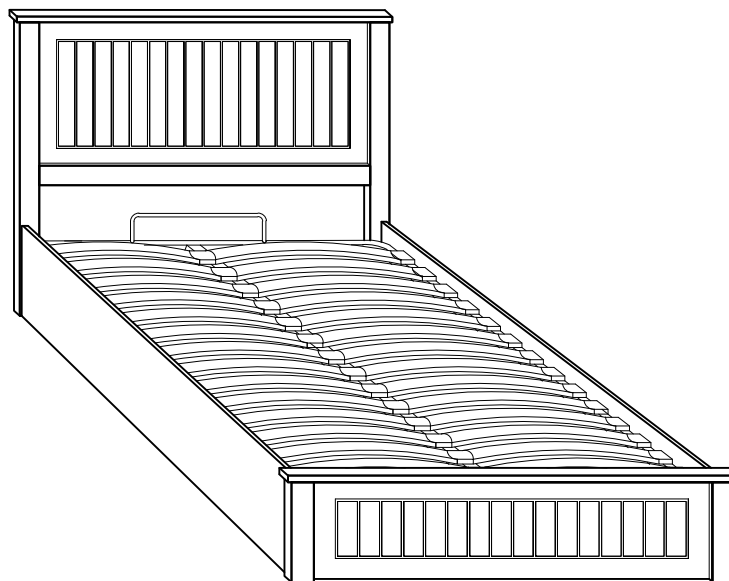



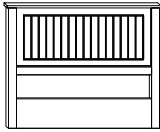
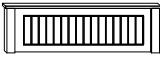

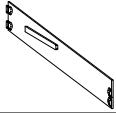
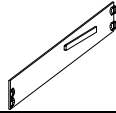
DO NOT push the bed frame as this will damage the legs.

Always lift the bed with two people to reposition.





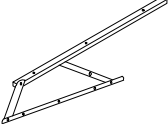





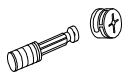



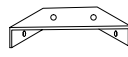

Keep any sharp objects away from the frame.

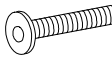

Part List

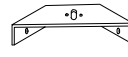
Part	Description	Box	Qty
1	Headboard 	1	1
2	Footboard 	1	1
3	Front Bottom panel 	1	1
4	Center & Back Bottom panel 	1	2
5	Side Rail 'Right' 	2	1
6	Side Rail 'Left' 	2	1
7	Storage Rail 	2	2
8	Ottoman Front 	3	1
9	Ottoman Back 	3	1
10	Ottoman Right 	3	1
11	Ottoman Left 	3	1
12	Ottoman Middle 	3	1
13	Bed Slat 	3	28
14	Strap 	3	1
15	Gas Lift Mechanism 'Right&Left' with Nuts 	4	2
16	Gas Spring 'Right&Left' 	4	2

Hardware list

Part	Description		Box	Qty
A	Dowel Pin 8 x 35mm		1	8
B	Mini Fit		1	4
C	JCBC Bolt M8 x 20mm		1	16
D	JCBC Bolt M8 x 16mm		1	16
E	Flat washer		1	30
F	M5 Allen Key		1	1
G	Bracket		3	4
H	Plastic Corner		3	4
I	Double Slat Cap		3	14
J	Single Slat Cap		3	28
K	JCBC Bolt M8 x 40mm		3	20
L	Hex Nut M8		3	20
M	M5 Allen Key		3	1
N	Wrench		3	1
O	Base Bracket		4	2
P	Mattress Stopper With Nuts		4	1
Q	Screw M8 x 45mm		4	6
R	Hex Nut M8		4	6

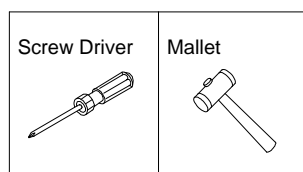

****You will need a small mallet and a screwdriver for assembly.**

Step 1: Insert hardware part (A) and (B) into the holes shown on the siderails (5) and (6) then attached the Storage rail (7) to the siderail as shown and tighten with a screwdriver.

Warning: DO NOT use any power tools as this may damage the frame and will invalid any claim

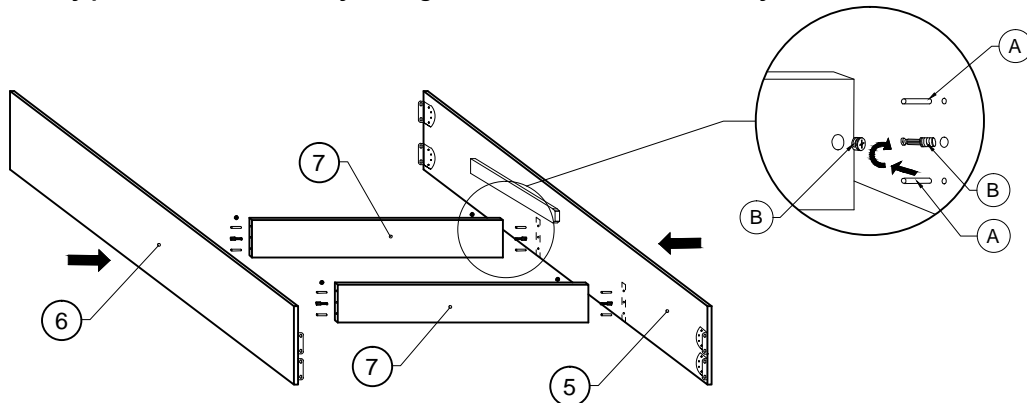

Step 2: Attach the headboard (1) and footboard (2) to the siderails (5) and (6) using hardware parts (C), (E) and (F).

Warning: DO NOT use any power tools as this may damage the frame and will invalid any claim

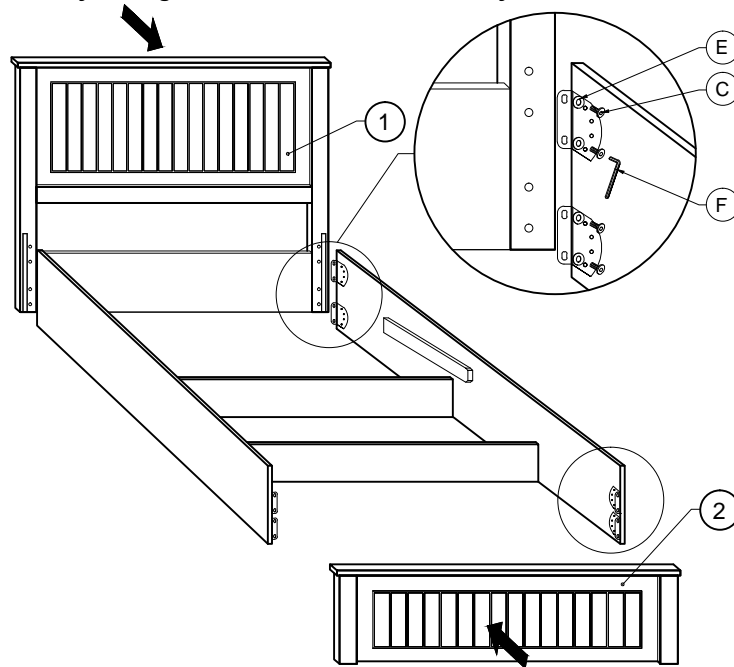

Step 3: Attach hardware part (O) to the footboard (2) and siderails (5) and (6) using hardware part (D) and (F).

Attach the gas spring (16) to the gas lift mechanism (15) using the included nut. Then attach the gas lift mechanism (15) to the siderails (5) and (6) using hardware parts (E), (D) and (F).

Warning: DO NOT use any power tools as this may damage the frame and will invalid any claim

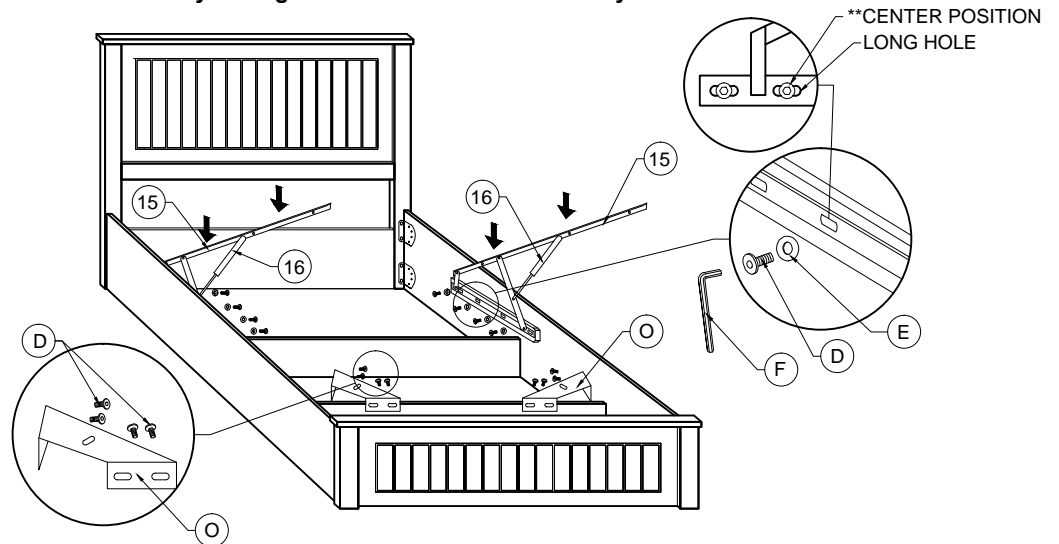

Step 4: Attach the ottoman back & Front (9) and (8) to the ottoman left & right (11) and (10) using hardware part (H). Then attach the ottoman middle (12) to the ottoman front (8) and back (9) using hardware parts (L), (K), (M) and (N).

Attach hardware part (G) to the ottoman front (8), back (9), left (11) and right (10) using hardware parts (L), (K), (M) and (N).

Warning: DO NOT use any power tools as this may damage the frame and will invalidate any claim

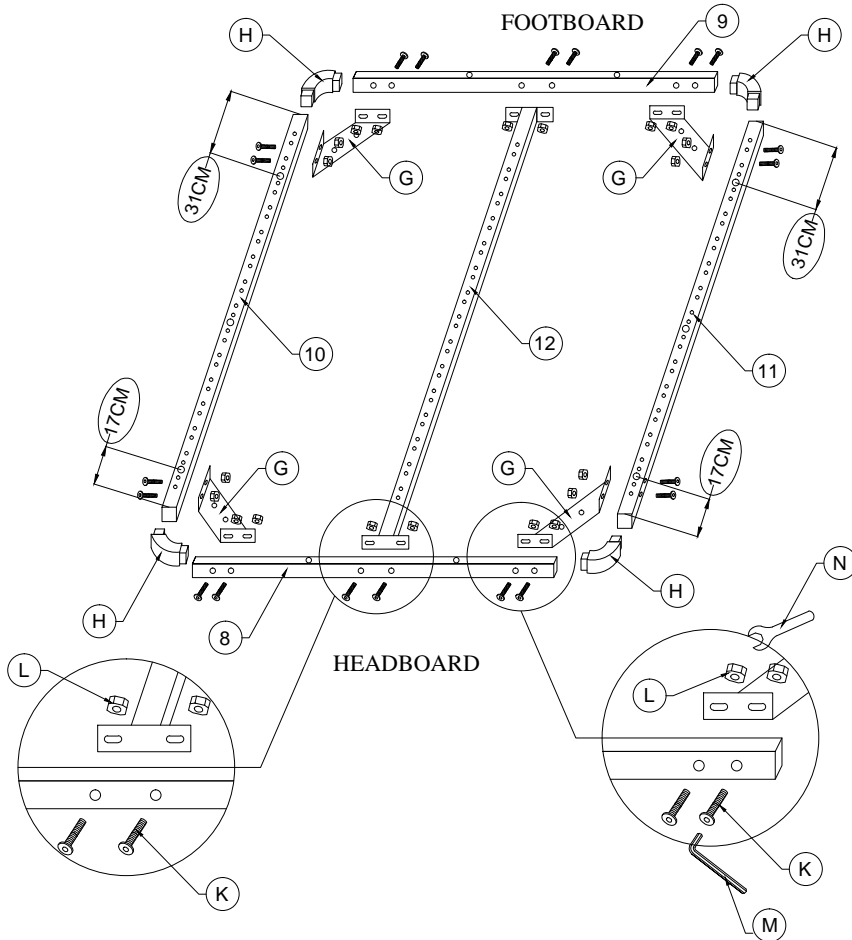

Step 5: Assemble the slats (13) by placing hardware (J) and (I) onto each end of the slat and push the slat set into the metal frame. Insert hardware part (P) into the ottoman front (8) as shown and tighten.

Warning: DO NOT use any power tools as this may damage the frame and will invalidate any claim

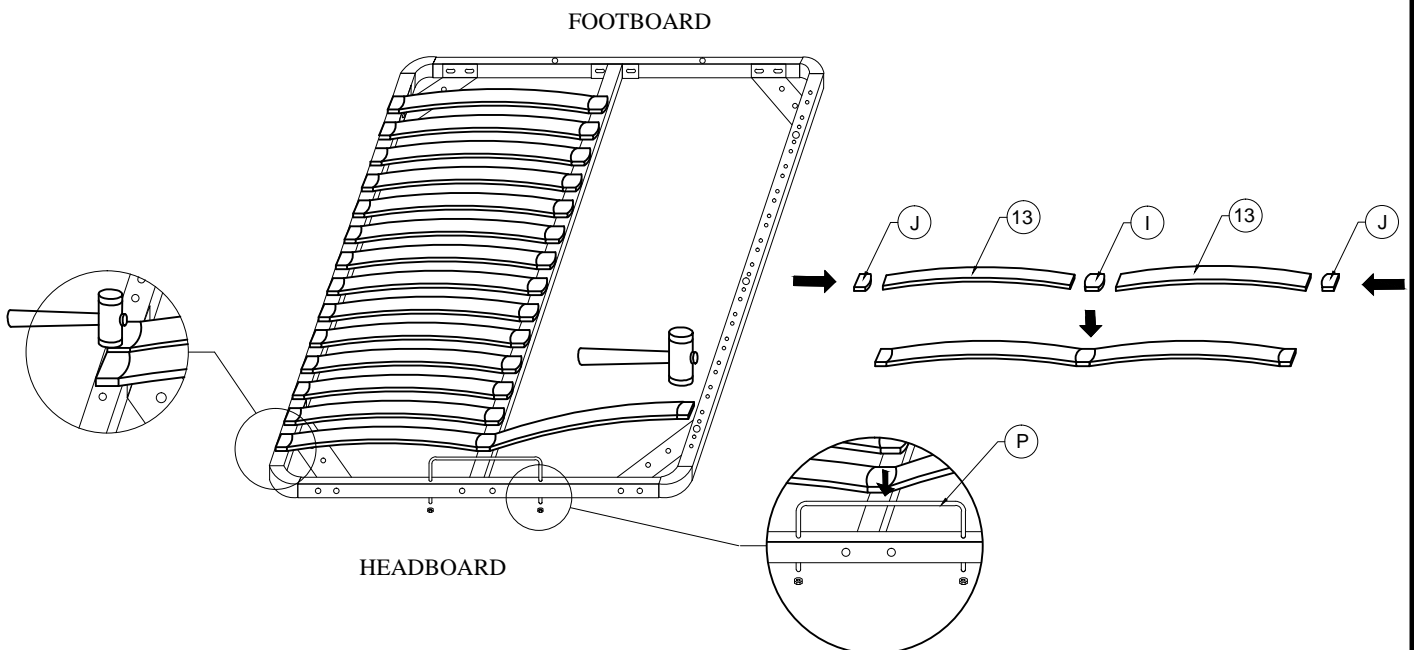

Step 6: Attach the metal frame on the gas lift mechanism using hardware parts (E), (N), (R) and (Q). Then attach the pull strap (14) to the metal frame.

Warning: DO NOT use any power tools as this may damage the frame and will invalidate any claim

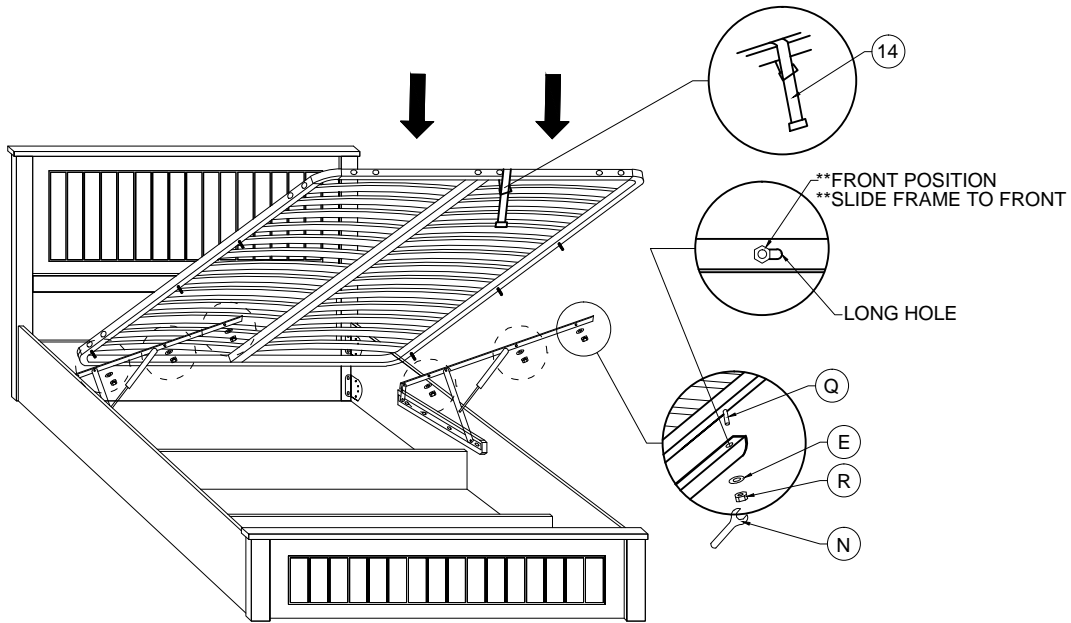

Step 7: Insert the Front, Centre & Back bottom panels (3) and (4) in the shown directions.

Warning: DO NOT use any power tools as this may damage the frame and will invalidate any claim

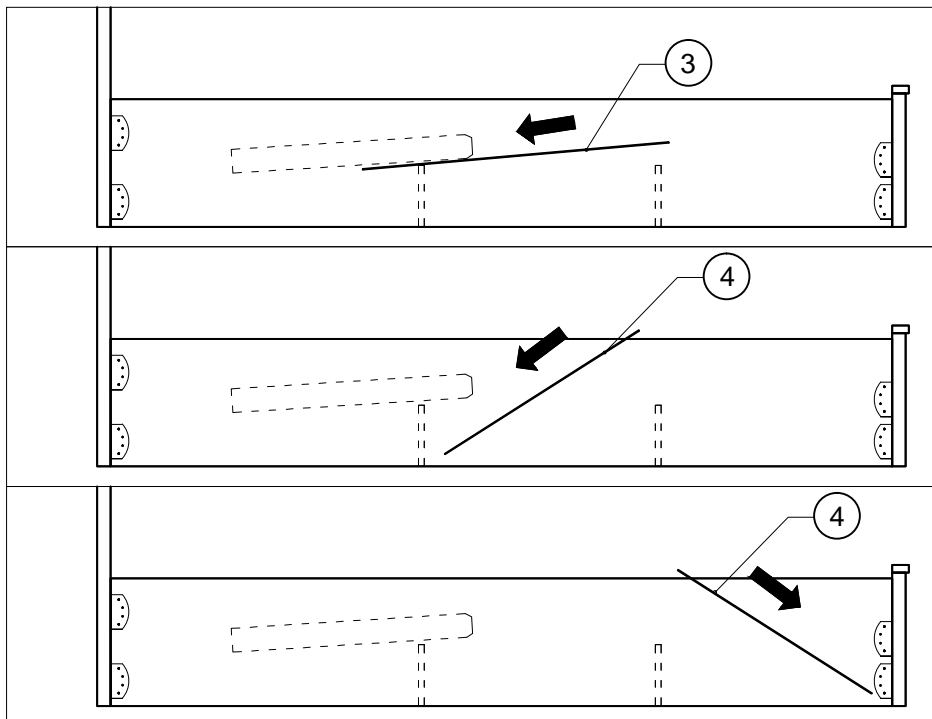

Step 8: Please use the safety lock for safety purpose.

Warning: DO NOT use any power tools as this may damage the frame and will invalid any claim

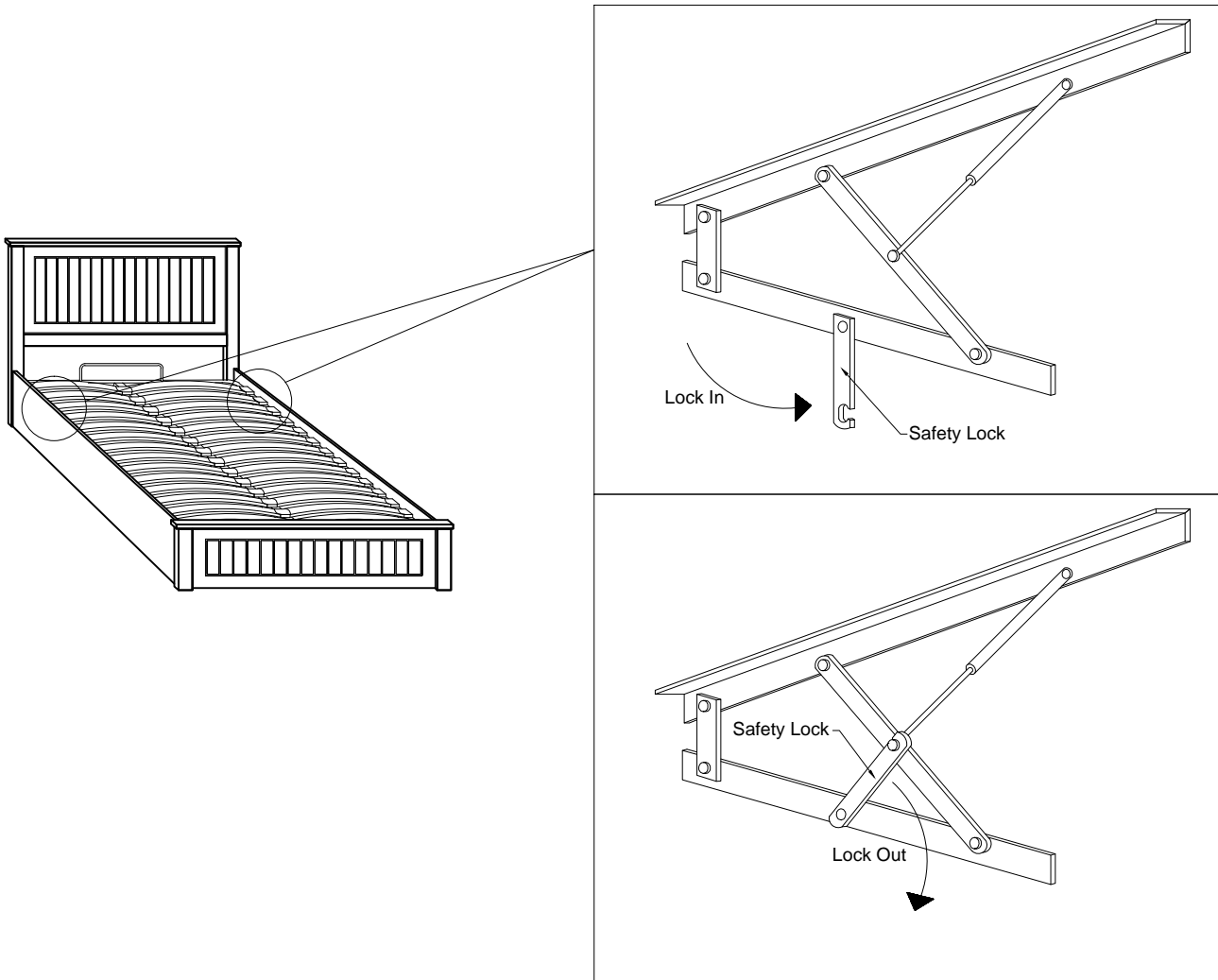

Additional Information:

- For complete product information, images and dimension diagrams please visit the website www.birlea.com
- If you have any issues with your item please contact the retailer directly you purchased it from who will be able to resolve issues with Birlea.
- Why don't you send us photos of your assembled furniture to info@birlea.com to be shared in our #birleahome feature on instagram.

Important Ottoman Safety Warnings

- Caution. This bed uses a pressurised mechanism.
- Use caution when operating - Always use two hands at arm's length, and only illustrated on the product.
- You must ensure the mattress is on the bed frame before lifting the mechanism - Failure to do so may result in injury.
- Please ensure Children and pets are kept away from the bed when operating the bed mechanism.
- If removing the mattress, make sure that the frame is secured as it could flip open.
- Only use the storage compartment when the frame is fully raised in the 'up' position.
- Do not remain on the bed whilst the lifting mechanism is in use.
- Beware of the Entrapment - Keep both hands clear of the mechanism when opening the mechanism.
- When lifting the bed remove all bedding - Except the fitted sheet.

