



## **ASSEMBLY INSTRUCTIONS** **135CM URBAN BED**

**IMPORTANT : READ THESE INSTRUCTIONS CAREFULLY BEFORE ASSEMBLING OR USING YOUR 135CM URBAN BED.**

**PLEASE KEEP THESE INSTRUCTIONS FOR FUTURE REFERENCE.**

### **HEALTH & SAFETY:**

DO NOT jump on this bed frame.

DO NOT use this bed frame if any parts are missing, damaged or worn.

DO NOT use this bed frame unless all fixings are secured.

Please Keep small parts out of reach of children.

Always use on level, even surface.

**WARNING: If this bed is placed on a non-carpeted floor you must place some protection under all legs to stop the bed frame from moving. If this is not adhered to there is no guarantee if the bed frame collapses.**

### **CARE & MAINTENANCE:**

Assemble in the room of use.

Periodically check all screws & fixings to ensure they are secure.

DO NOT push the bed frame as this will damage the legs.

Always lift the bed with two people to reposition.

Keep any sharp objects away from the bed frame.

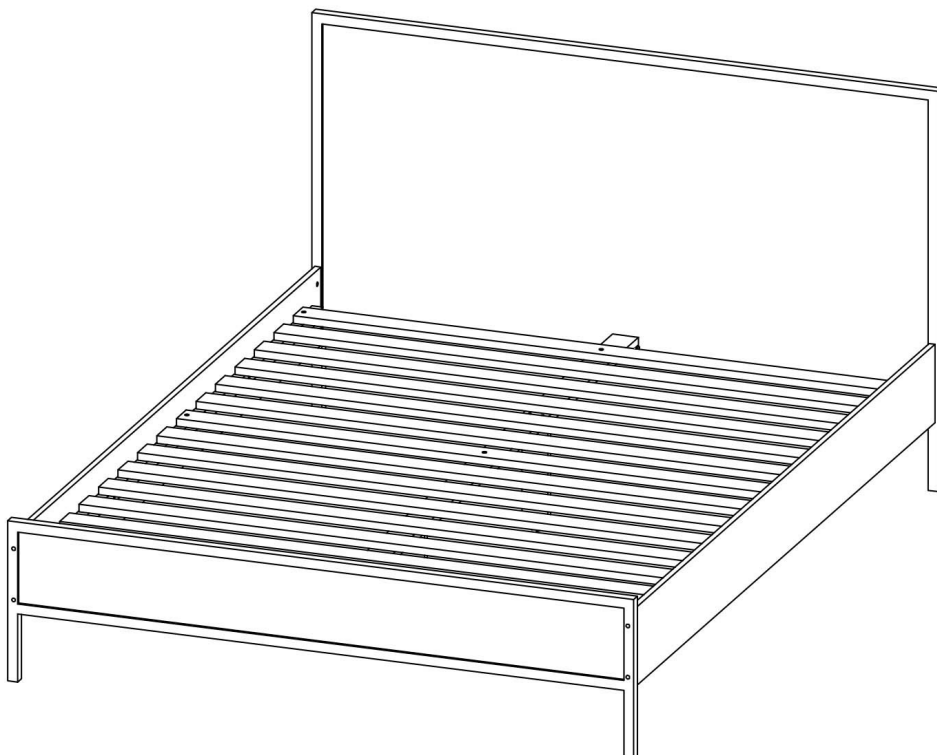

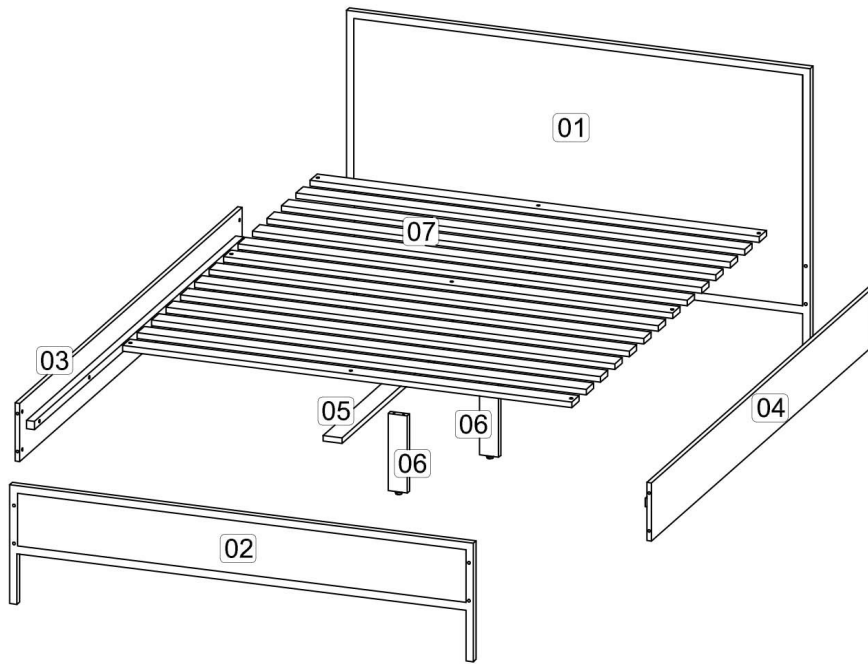

Parts List			Hardware List		
Part	Description	Qty	Part	Description	Qty
01	Headboard panel	1	A	JCBC Screw M6 x 60mm	8
02	Tailstock panel	1	B	JRN Nut	8
03	Bed side panel ( Left )	1	C	Allen key M4	1
04	Bed side panel ( Right )	1	D	M3.5 x 16mm C.B Screw	32
05	Center slat	1	E	M4 x 38mm C.B Screw	9
06	Slat support	2	F	M6 x 50mm CSK Cap Wood screw	4
07	Bed slat	1 Set	G	Bracket L	2
			H	Bracket U	2

**\*\* You will need a screwdriver for assembly.**

**Step 1: Prepare these parts for assembly using hardware parts D, G and H. DO NOT use any power tools as this may damage the frame and will invalidate any claim.**

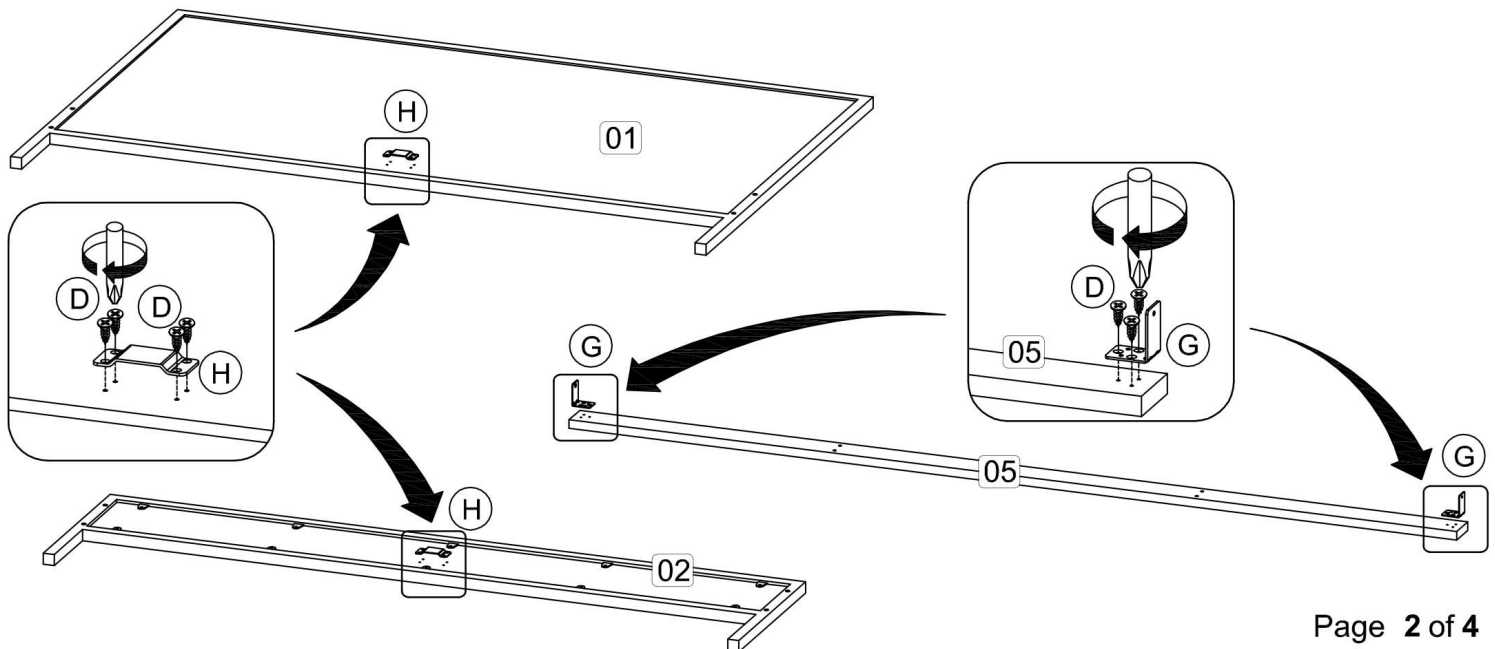

**Step 2:** Fix the panel (3) and (4) to panel (1) and (2) using hardware part A, B and C.

Please note that do not fully tighten the hardware A before assembling the panel (5).

**DO NOT use any power tools as this may damage the frame and will invalidate any claim.**

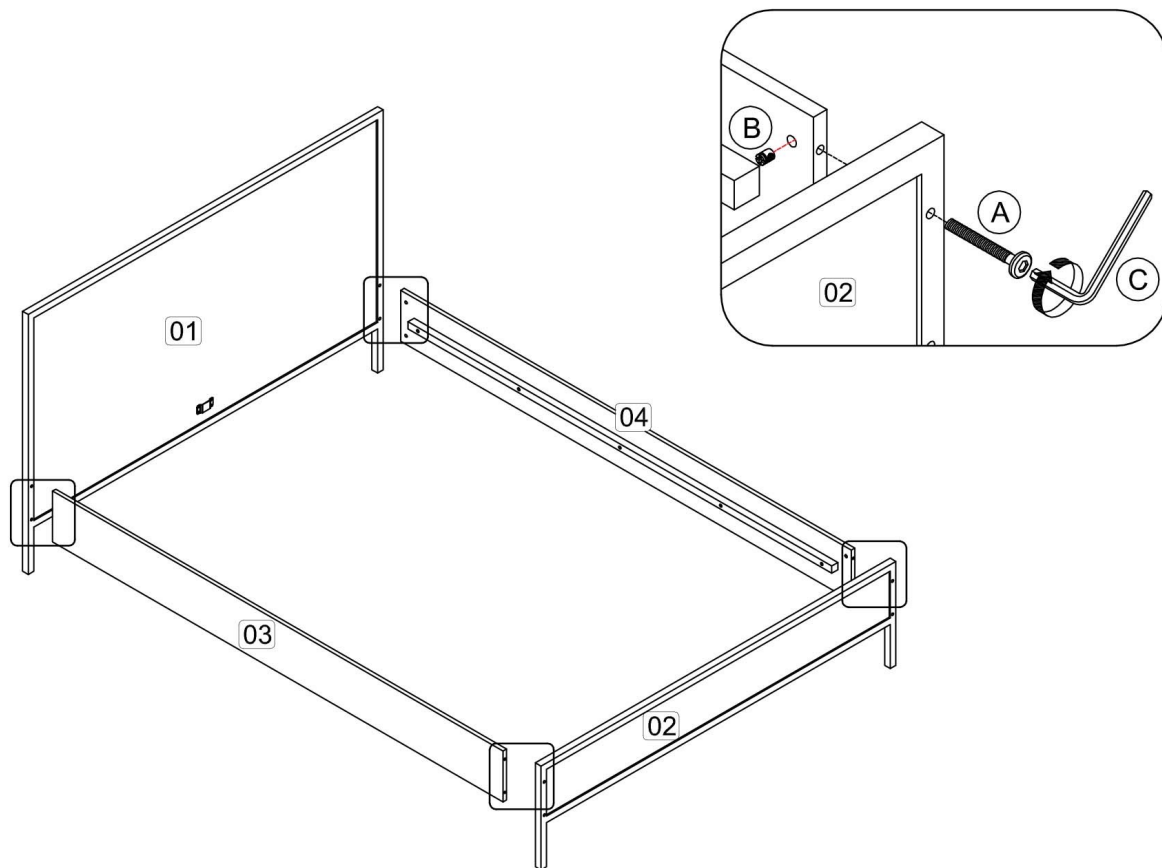

**Step 2:** Attach the panel (5) to panel (6) using hardware C and F.

Please note that the panel (6) has a plastic adjuster at the bottom to unscrew and adjust the height of panel (5) if necessary.

**DO NOT use any power tools as this may damage the frame and will invalidate any claim.**

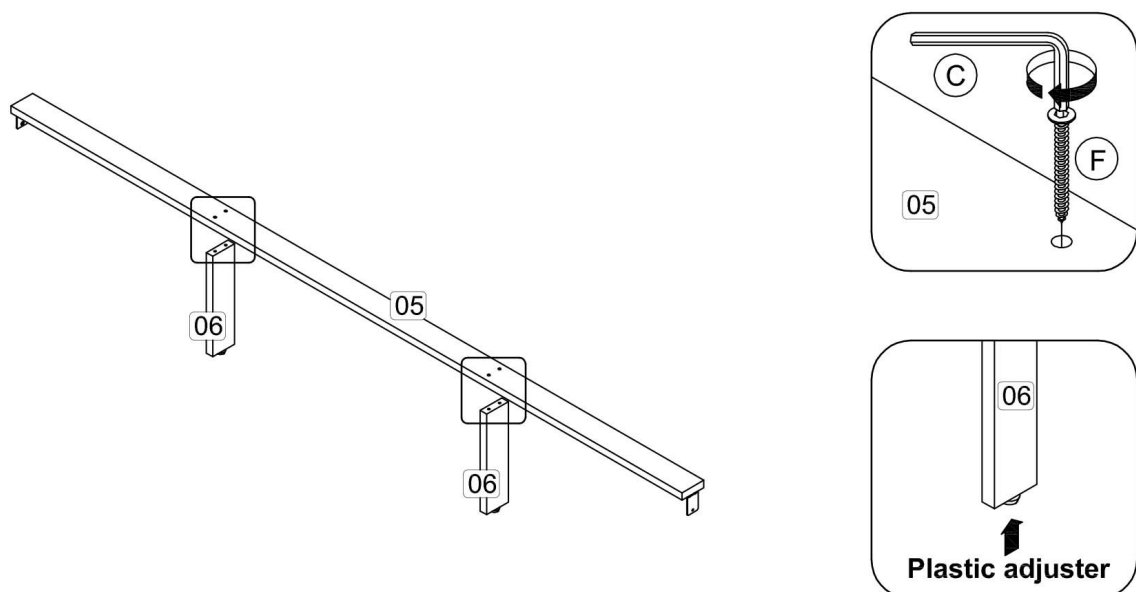

**Step 3:** Attach the hardware G at panel (5) to hardware H at panel (1) and (2) using hardware D with a screwdriver (not provided).

**DO NOT use any power tools as this may damage the frame and will invalidate any claim.**

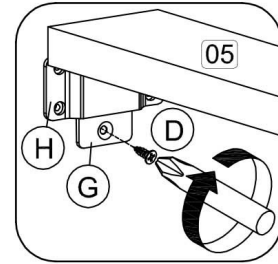
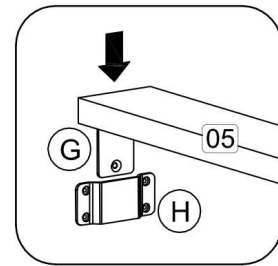
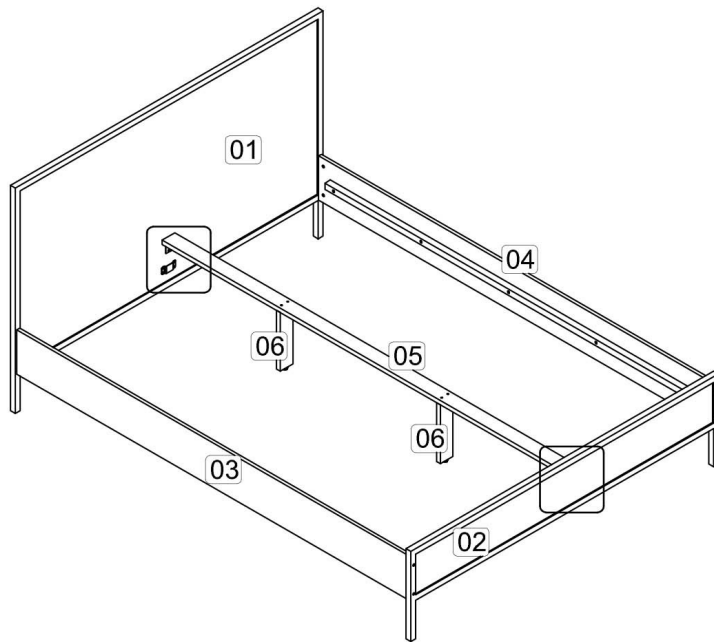

**Step 4:** Attach the panel (7) to panel (3), (4) and (5) using hardware E with a screwdriver (not provided).

**DO NOT use any power tools as this may damage the frame and will invalidate any claim.**

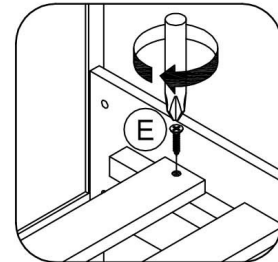
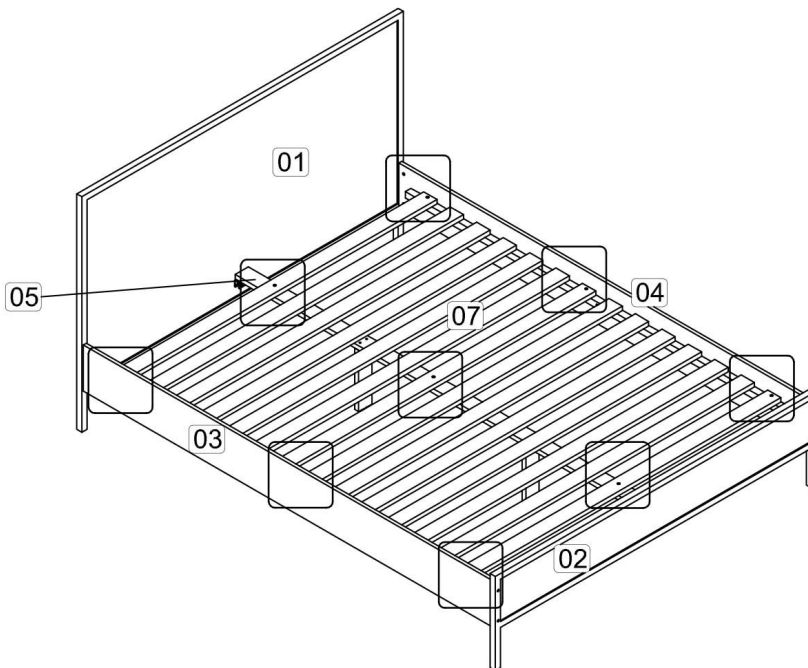

### Additional Information:

- For complete product information, images and dimension diagrams please visit the website [www.birlea.com](http://www.birlea.com)
- If you have any issues with your item please contact the retailer directly you purchased it from who will be able to resolve any issues with Birlea.
- Why don't you send us photos of your assembled furniture to [info@birlea.com](mailto:info@birlea.com) to be shared in our #birleahome feature on instagram.



**Birlea**

Suppliers of inspiration