



# Birlea

Suppliers of inspiration

Vendor: S000299



## ASSEMBLY INSTRUCTIONS MALVERN HIGH END 5' BED

**IMPORTANT: READ THESE INSTRUCTIONS CAREFULLY BEFORE ASSEMBLING OR USING YOUR MALVERN HIGH END 5' BED FRAME.**

PLEASE KEEP THESE INSTRUCTIONS FOR FUTURE REFERENCE.

### HEALTH & SAFETY:

DO NOT jump on this bed frame.

DO NOT use this bed frame if any parts are missing, damaged or worn.

DO NOT use this bed frame unless all fixings are secured.

Please keep small parts out of reach of children.

Always use on a level, even surface.

**WARNING:** If this bed is placed on a non-carpeted floor you must place some protection under all legs to stop the bed frame from moving. If this is not adhered to there is no guarantee if the bed frame collapses.

### CARE & MAINTENANCE:

Assemble in the room of use.

Periodically check all screws & fixings to ensure they are secure.

DO NOT push the bed frame as this will damage the legs.



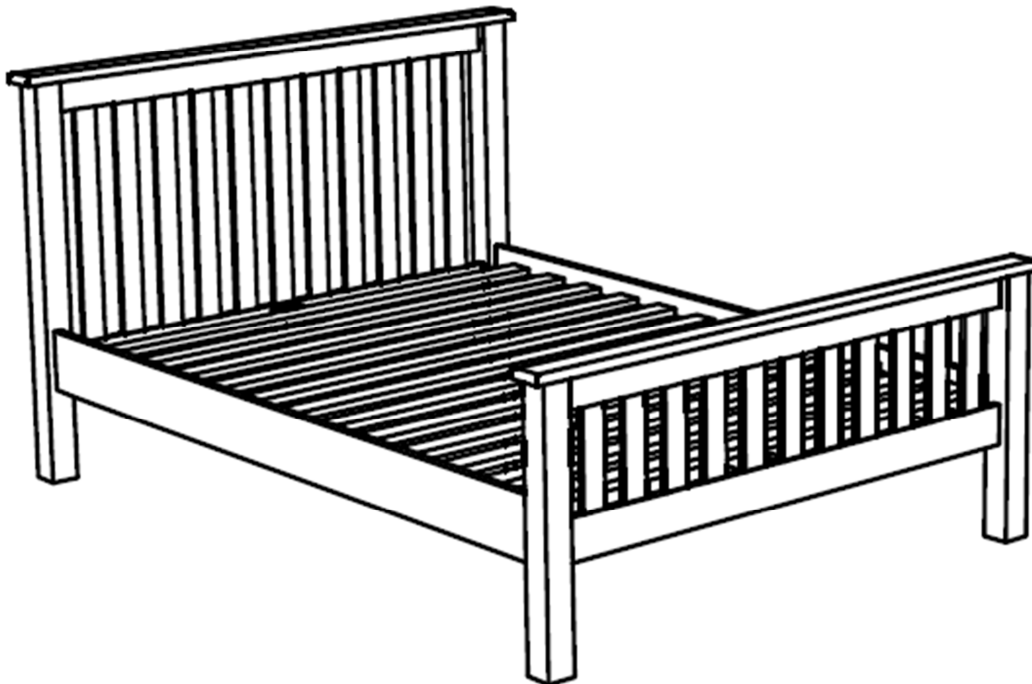

Always lift the bed with two people to reposition.

Keep any sharp objects away from the frame.



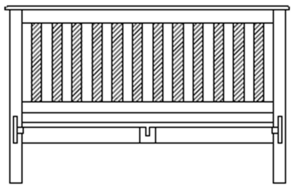
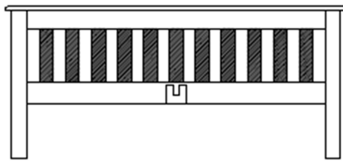
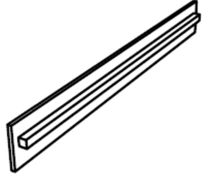



[www.birlea.com](http://www.birlea.com)

**Parts List**

		
1. Headend (Box 1)	2. Footend (Box 2)	3. Side Rail Pack (Box 3)
		
4. Centre Support Bar (Box 3)	5. Support Leg (Box 3)	6. Slat Pack (13) (Box 4)

**Hardware List (found in box 1)**

Part	Description	Qty
A	M8 x 20 mm Bolt 	8
B	4 x 30 mm Screw 	6
C	M8 x 40 mm Bolt 	1
K1	M13 Spanner 	1
K	Allen Key 	1

**\*\*You will need a screwdriver (not provided).**

Step 1: Attach the side rails (3) to the headend (1) and footend (2) using hardware parts A and K. DO NOT use any power tools as this may damage the frame and will invalidate any claim.

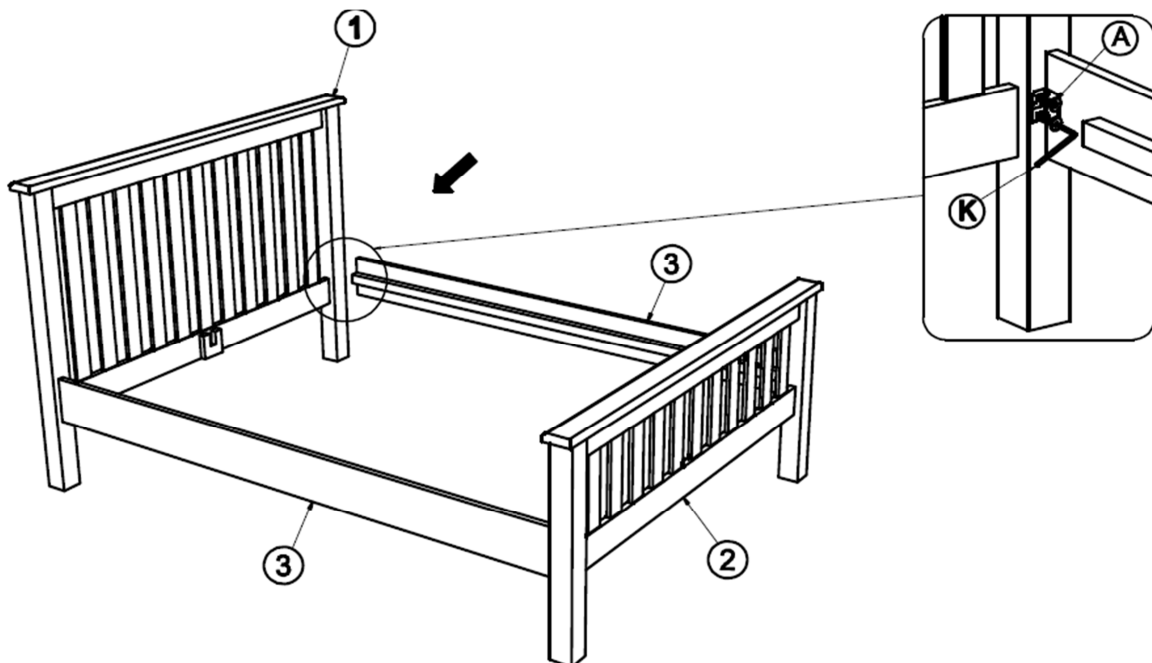

Step 2: Attach the support leg (5) to the centre rail (4) and position on the frame.  
DO NOT use any power tools as this may damage the frame and will invalidate any claim.

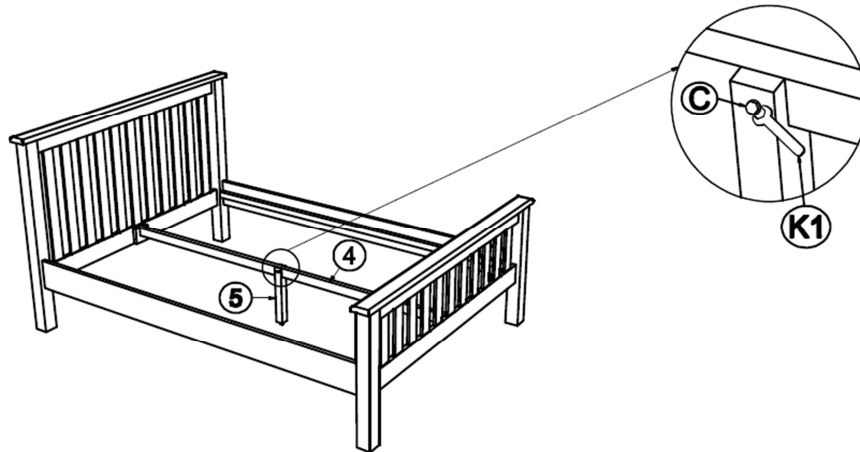

Step 3: Place the slats (6) onto the frame and secure using hardware part B and a screwdriver (not provided).

DO NOT use any power tools as this may damage the frame and will invalidate any claim.

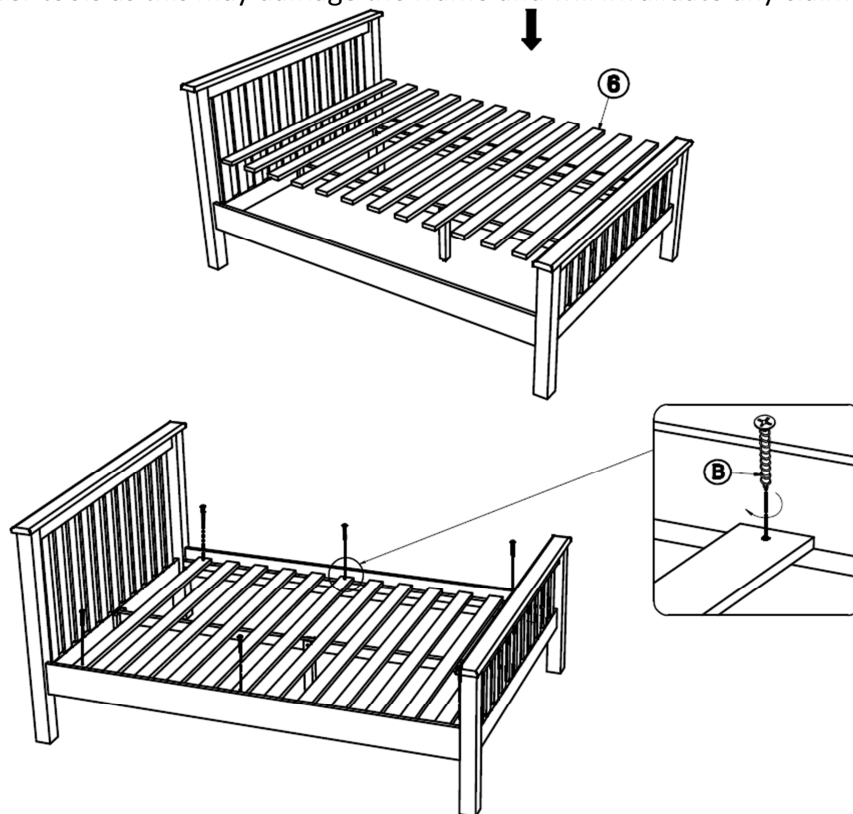

### Additional Information:

- For complete product information, images and dimension diagrams please visit the website [www.birlea.com](http://www.birlea.com)
- If you have any issues with your item please contact the retailer directly you purchased it from who will be able to resolve any issues with Birlea.
- Why don't you send us photos of your assembled furniture to [info@birlea.com](mailto:info@birlea.com) to be shared in our #birleahome feature on Instagram.



**Birlea**

Suppliers of inspiration