

## ASSEMBLY INSTRUCTIONS

### NIMBUS (YORK) SINGLE BED



Minimum No. of people recommended to assemble this product :

2





Approx assembly time :



1/2 hour

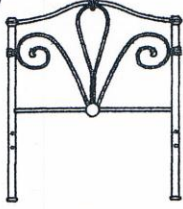

**Before you start, here is some helpful advice**

1. We suggest you spend a short time reading through this leaflet and then follow the simple step by step instructions.
2. If you follow the instructions carefully the end result should be worth the effort.
3. Do not discard any of the packaging until you have checked that you have all the parts and the pack of fittings.
4. Assemble this product on a carpet.
5. To ensure an easier assembly, we strongly advise that all fittings are only finger tightened during initial assembly only. Upon completion of the assembly should all fixing points be fully tightened.
6. We recommend a periodic check on all fixing points to make sure they remain fully tightened.
7. Keep any fittings out of children's reach.

Component parts and fittings contained in the box

<p><b>A</b></p>  <p>1 PC</p>	<p><b>B</b></p>  <p>1 PC</p>	<p><b>C</b></p>  <p>2 PCS</p>	<p><b>D</b></p>  <p>1 PC</p>
---	---	---	---

<p><b>E</b></p>  <p>13 PCS</p>	<p><b>F</b></p>  <p>26 PCS</p>	<p><b>G</b></p>  <p>4 PCS</p>	
---	---	---	--

<p><b>1</b></p>  <p>M6x20mm 8 PCS</p>	<p><b>2</b></p>  <p>M6x35mm 2 PCS</p>	<p><b>3</b></p>  <p>M4 Allen Key 1 PC</p>	
--	--	---	--

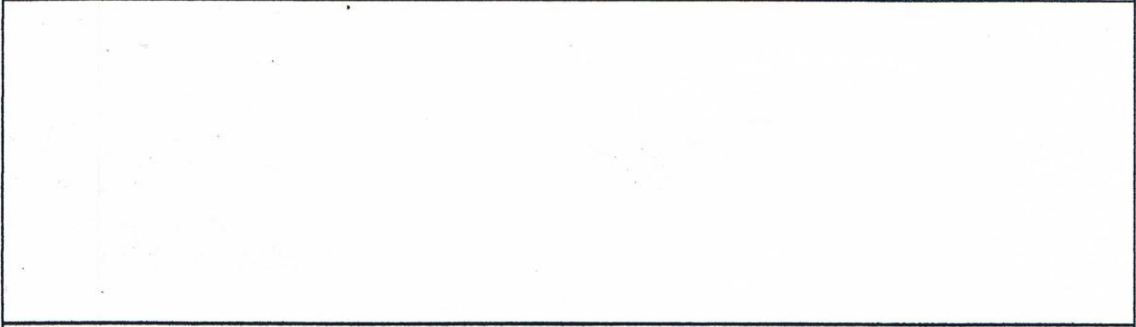

TWO PEOPLE NEEDED TO ASSEMBLE THIS BED

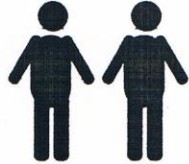

# ASSEMBLY

## STEP 1

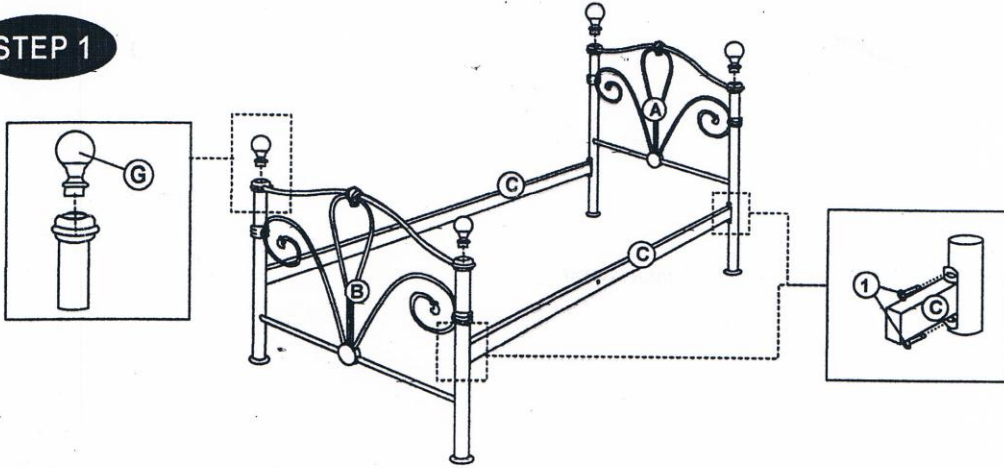

## STEP 2

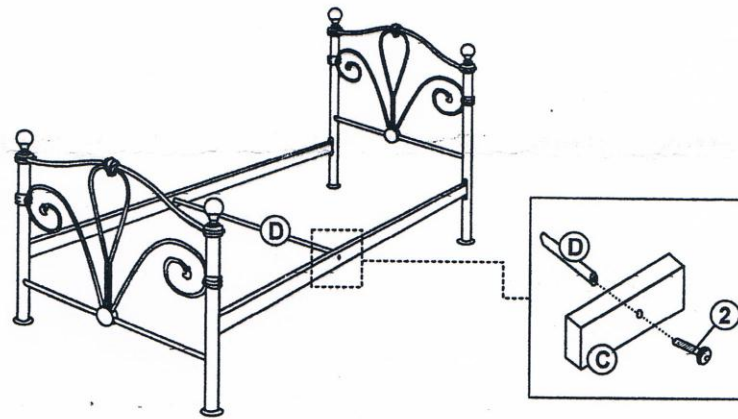

## STEP 3

