



Birlea

Suppliers of inspiration

Assembly Instructions

Thank you for
purchasing a
Birlea product.

For a chance to win a *Love 2 Shop* voucher simply post a picture of your new product on your preferred social channels tagging Birlea Furniture and using the hashtag **#ShareYourStyle** and **#Birlea**. One winner will be selected at random each month.

To view our full terms and conditions please visit our website. www.birlea.com

Are you happy with your purchase?

Yes: That's great, we would love to hear more from you. Please leave us a review on our social media channels or Trustpilot. Your feedback will be greatly appreciated.

No: If for any reason there is something missing, indifferent or incorrect with your order, please contact the retailer you purchased the item from. We will work with the retailer to resolve your issue as quickly as possible.



www.birlea.com

ASSEMBLY INSTRUCTIONS

90CM BECKTON BED

IMPORTANT: READ THESE INSTRUCTIONS CAREFULLY BEFORE ASSEMBLING OR USING YOUR 90CM BECKTON BED.

PLEASE KEEP THESE INSTRUCTIONS FOR FUTURE REFERENCE.

HEALTH & SAFETY:

DO NOT jump on this bed frame.

DO NOT use this bed frame if any parts are missing, damaged or worn.

DO NOT use this bed frame unless all fixings are secured.

Please keep small parts out of reach of children.

Always use on a level, even surface.

WARNING: If this bed is placed on a non-carpeted floor you must place some protection under all legs to stop the bed frame from moving. If this is not adhered to there is no guarantee if the bed frame collapses.

CARE & MAINTENANCE:

Assemble in the room of use.

Periodically check all screws & fixings to ensure they are secure.

DO NOT push the bed frame as this will damage the legs.

Always lift the bed with two people to reposition.

Keep any sharp objects away from the frame.

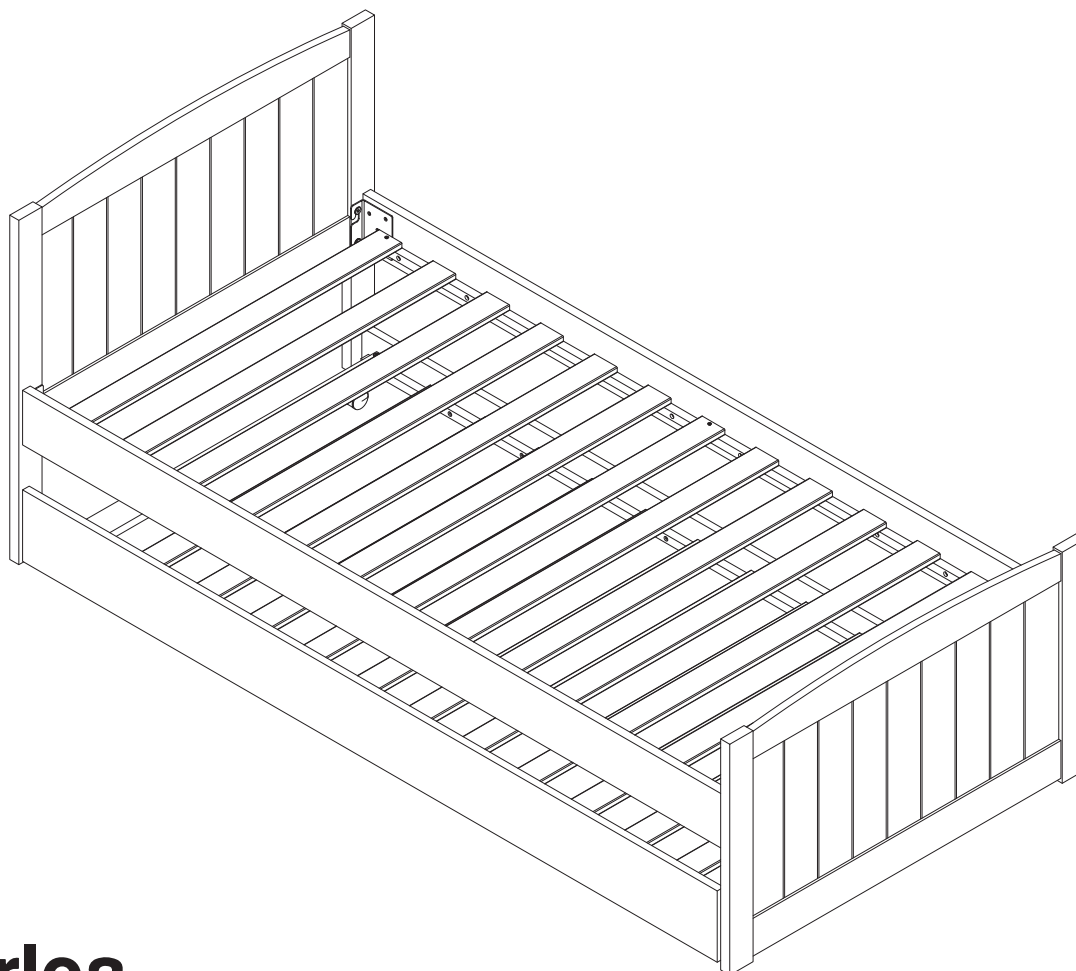

Birlea

Suppliers of inspiration

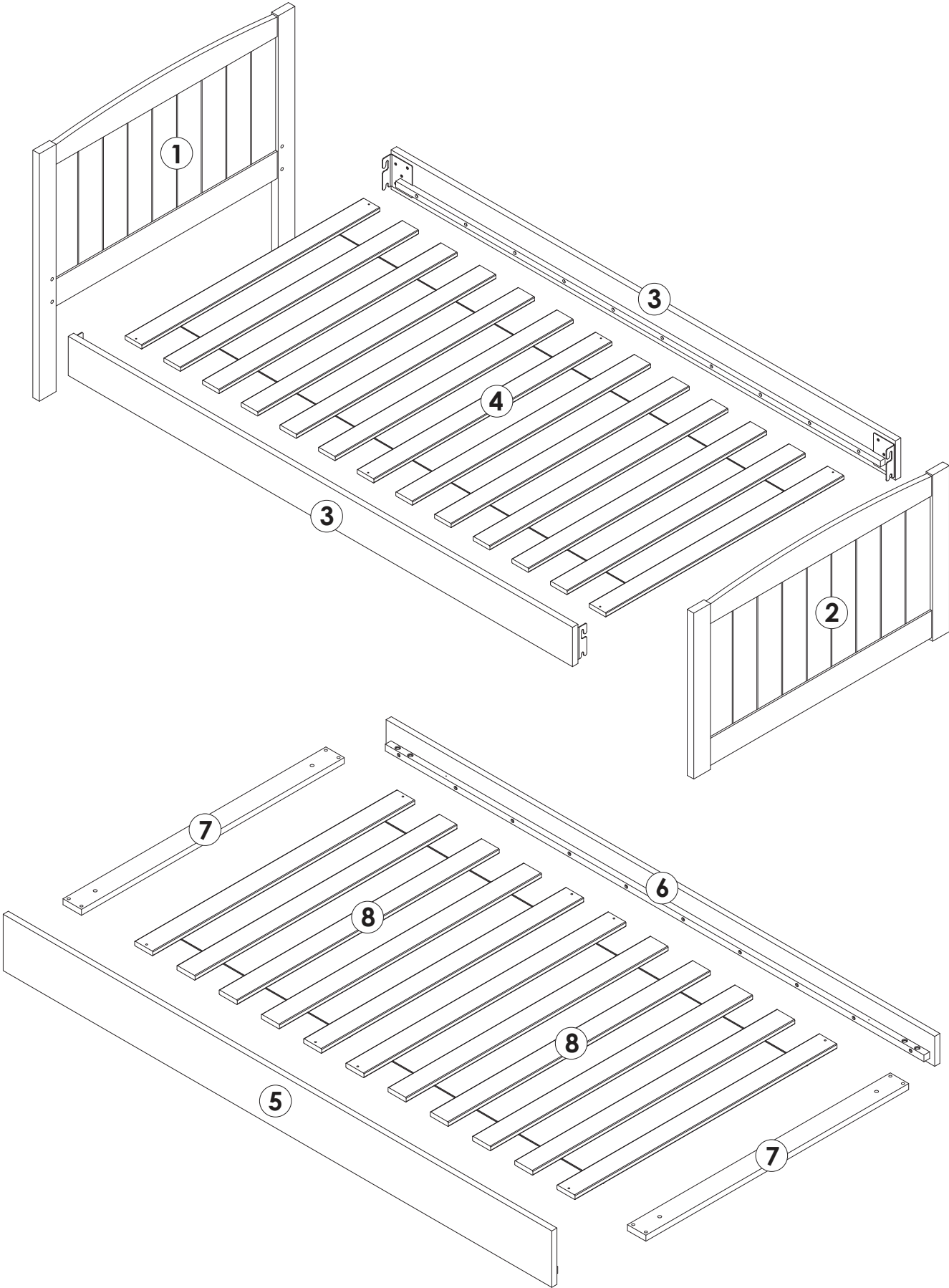









* Trundle bed can be assembled either side.

Part List

Cabin Bed				Trundle Bed			
Part	Description	Box	Qty	Part	Description	Box	Qty
1	Headboard	1	1	5	Front Side Rail	3	1
2	Footboard	1	1	6	Rear Side Rail	3	1
3	Side Rail	2	2	7	Rail Support	3	2
4	Wooden Slat	1	13	8	Wooden Slat	3	5 + 6

Hardware List (found in box 3)

90CM Bed			Trundle Bed		
Part	Description	Qty	Part	Description	Qty
A	JCBB Bolt (M8 x 20MM) 	8	D	JCBC Bolt (M6 x 35MM) 	8
B	CSK C/B Screw (M4 x 32MM) 	6	E	CSK C/B SCrew (M4 x 32MM) 	8
C	Allen Key (M5 x 60MM) 	1	F	Socket 	4
** You will need a Crosshead Screw Driver and Rubber Hammer (not provided)			G	Castor 40SA-C 	4
			H	Allen Key (M4 x 60MM) 	1



Step 1: Insert hardware **(A)** into holes on the **Headboard (1)** and **Footboard (2)**, but **DO NOT** tighten it up. Slot **Side Rail (3)** onto the already attached hardware **(A)**, tighten it up fully by using hardware **(C)**.

DO NOT use any power tools as this may damage the frame and will invalidate any claim.

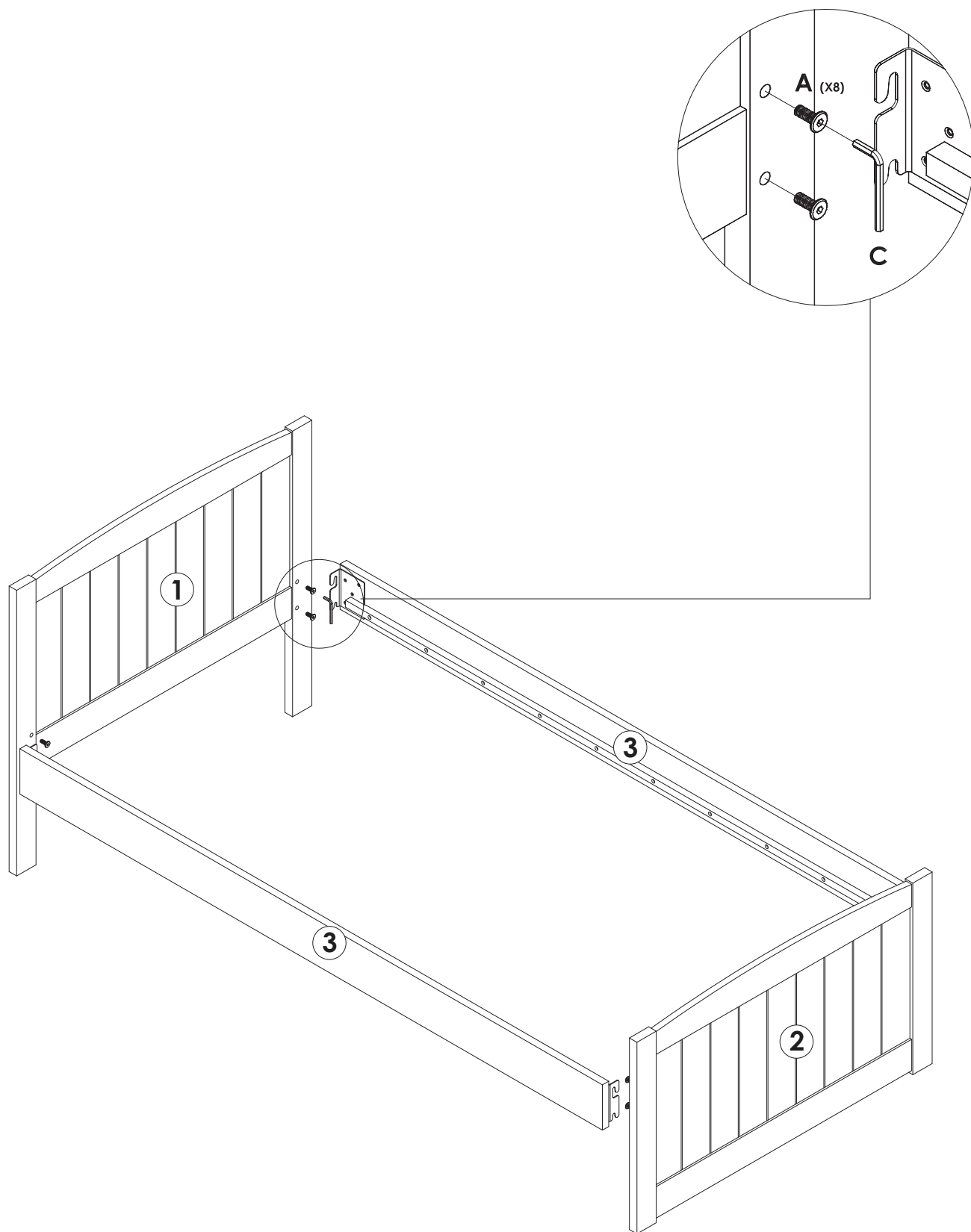

Step 2: Attach and secure **Wooden Slat (4)** onto both **Side Rail** by using hardware **(B)**, tighten it up by using a Crosshead Screw Driver (not provided). Go on to complete the entire assembly. **DO NOT** use any power tools as this may damage the frame and will invalidate any claim.

*Align both **Side Rail** before tightening the screws.

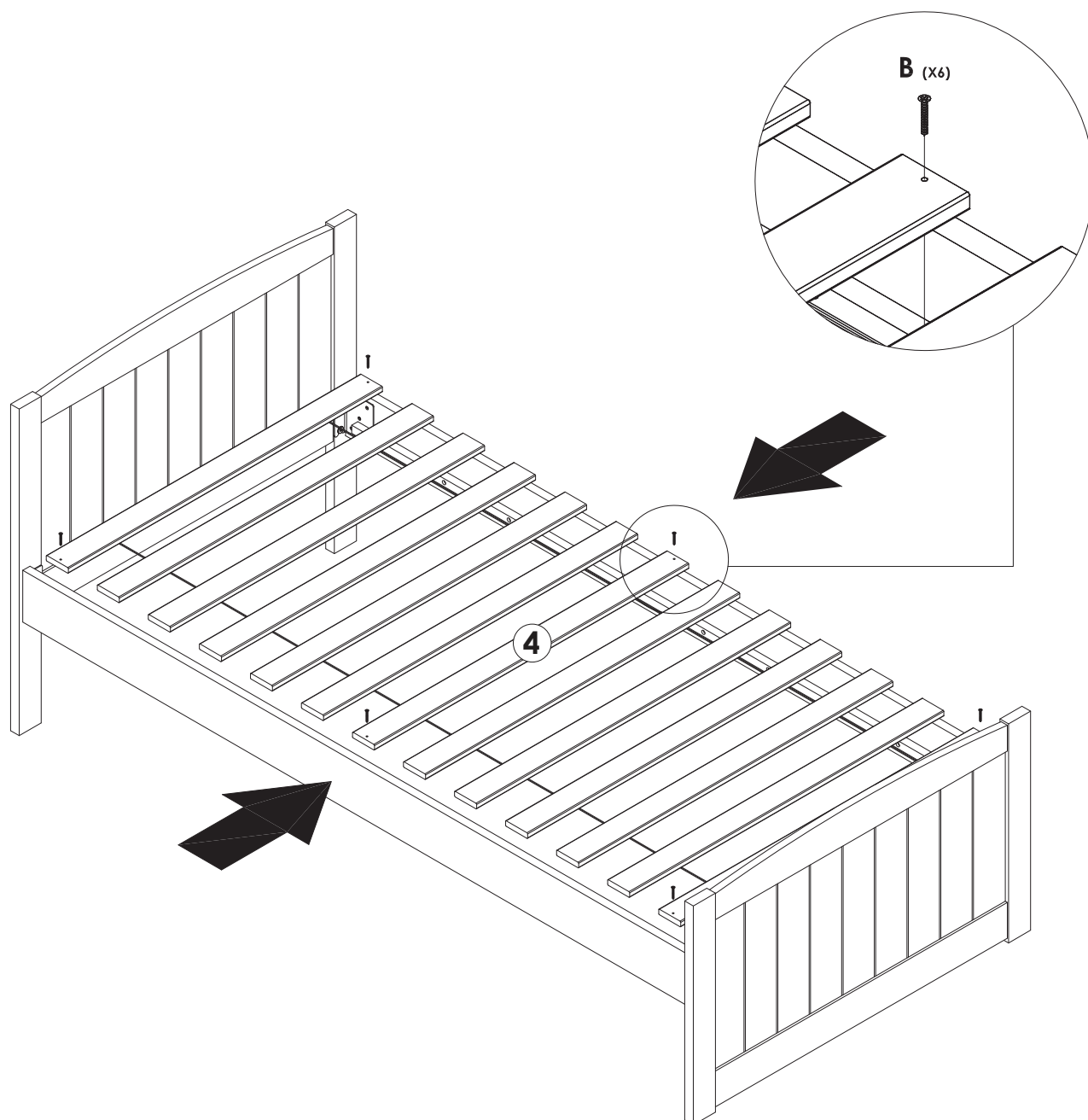

Step 3: Slot hardware (F) into Ø10MM holes on both Rail Support (7) from beneath, follow it up by slotting hardware (G) into hardware (F).
 DO NOT use any power tools as this may damage the frame and will invalidate any claim.

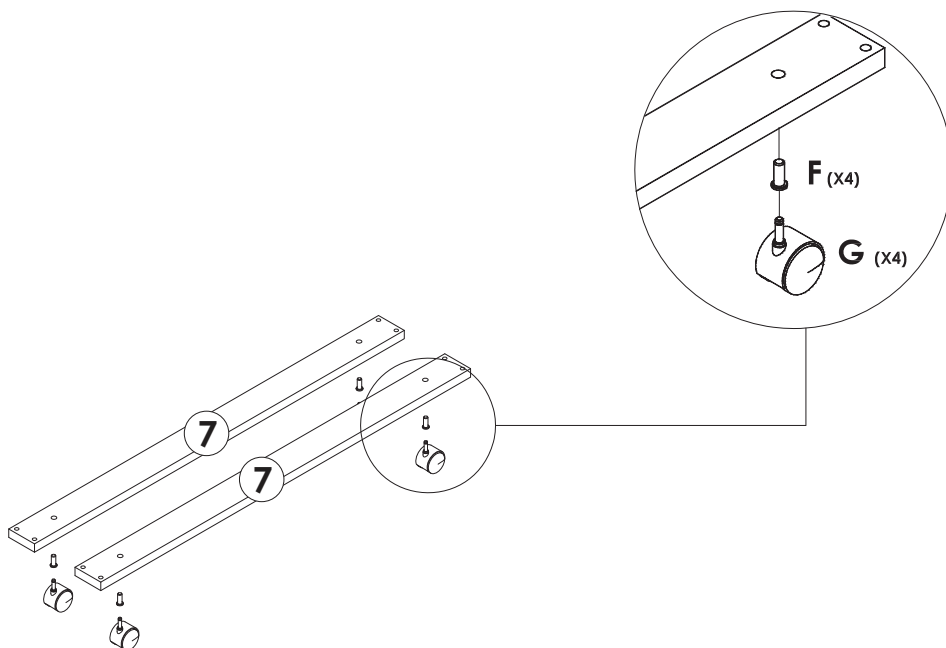

Step 4: Attach both Rail Support (7) onto Front Side Rail (5) and Rear Side Rail (6) by using hardware (D), tighten it up by using hardware (H).
 DO NOT use any power tools as this may damage the frame and will invalidate any claim.

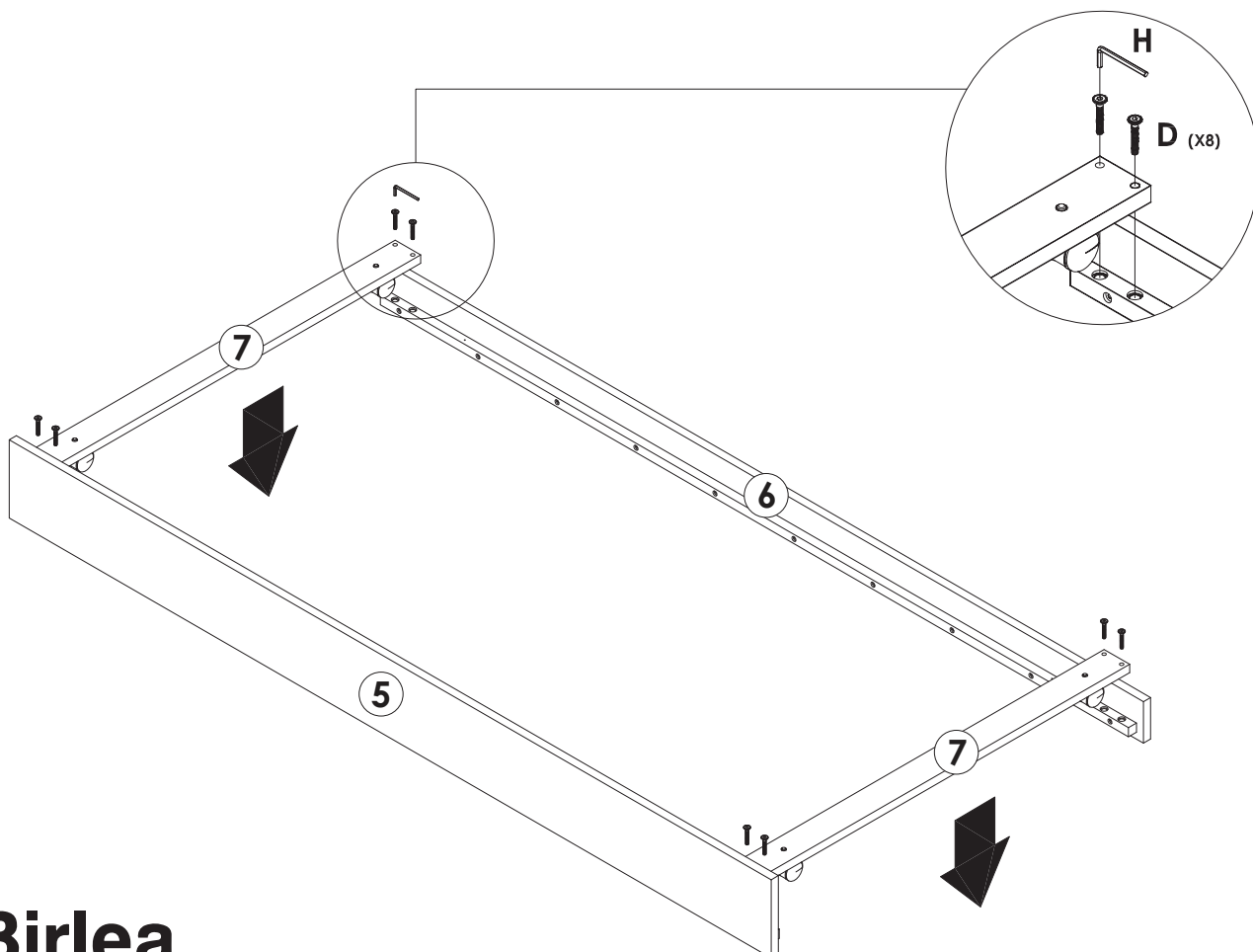

Step 5: Attach and secure both sets of **Wooden Slat (8)** onto both **Front Side Rail** and **Rear Side Rail**. Firstly, secure both ends of **Wooden Slat (8)** by using hardware (**E**) based on marking holes provided, then pull both sets of **Wooden Slat (8)** to center and secure it with hardware (**E**), tighten it up by using a Crosshead Screw Driver (not provided). Go on to complete the entire assembly.

DO NOT use any power tools as this may damage the frame and will invalidate any claim.

* Align both **Front Side Rail** and **Rear Side Rail** before tightening the screws.

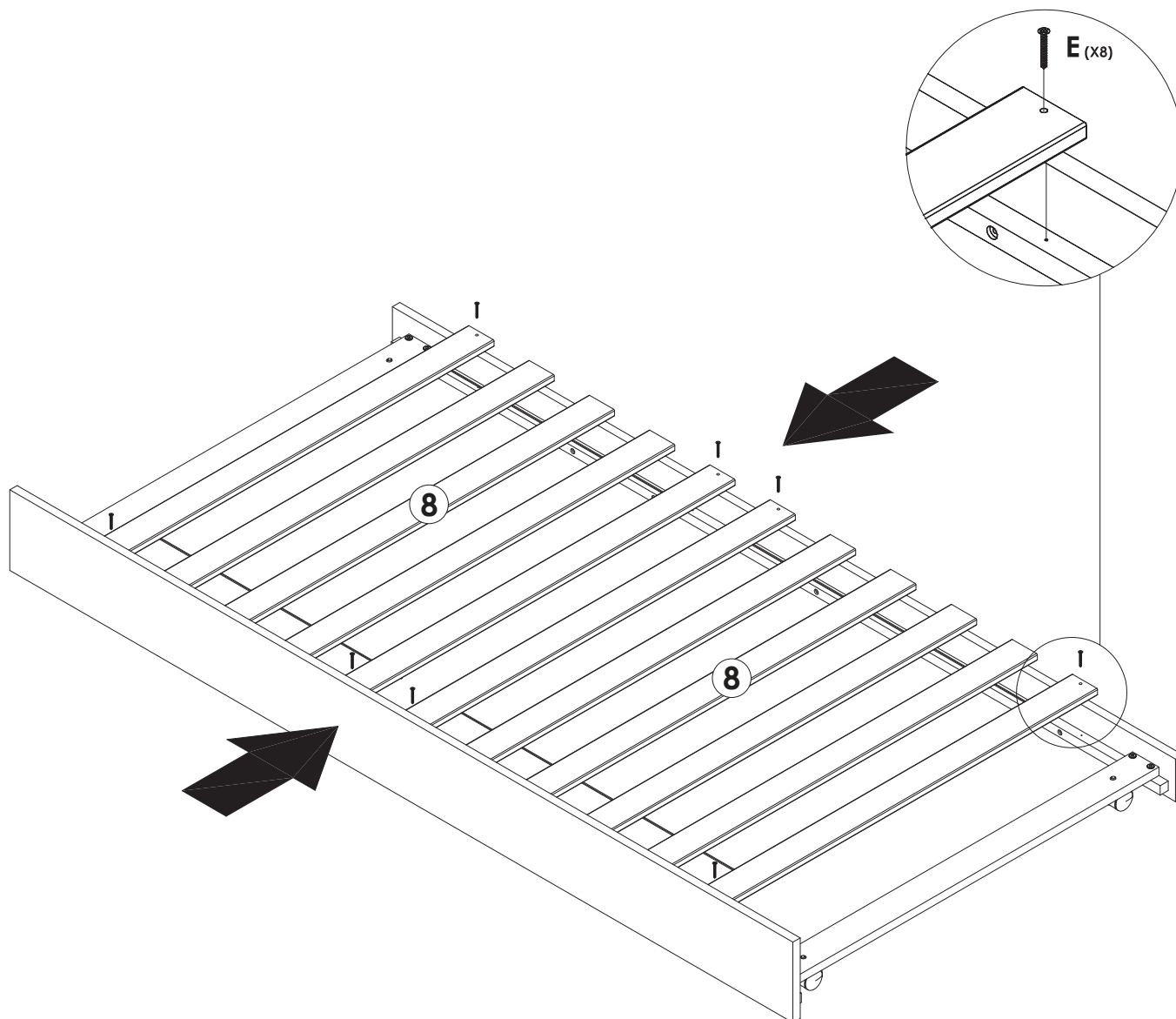

Additional Information:

- For complete product information, images and dimension diagrams please visit the website www.birlea.com
- If you have any issues with your item please contact the retailer directly you purchased it from who will be able to resolve any issues with Birlea.
- Why don't you send us photos of your assembled furniture to info@birlea.com to be shared in our #birleahome feature on Instagram.



Birlea

Suppliers of inspiration