

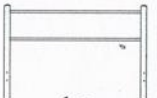















MODEL :METAL POST / SPRUNG WOOD BED BASE

SIZE :SMALL DOUBLE / DOUBLE / QUEEN / KING SINGLE / KING BED

MODENA 120cm to 150cm BED

Part List							Hardware								
HEAD BOARD	FOOT BOARD	SIDE RAIL	CROSS RAIL	CENTRE RAIL	SUPPORT LEG	SPRUNG WOOD	SINGLE CONNECTOR	DOUBLE CONNECTOR	M6 X 50mm	M6 X 40mm	M6 X 20mm	FLAT WASHER	M6 HEX NUT	SPANNER	ALLEN KEY M4
 1 pc	 1 pc	 2 pcs	 3 HOLE 3 pcs	 1 pc	 3 pcs	 24pcs	 24pcs	 12 pcs	 3 pcs	 11 pcs	 8 pcs	 10 pcs	 14 pcs	 1 pc	 1 pc

Step 1

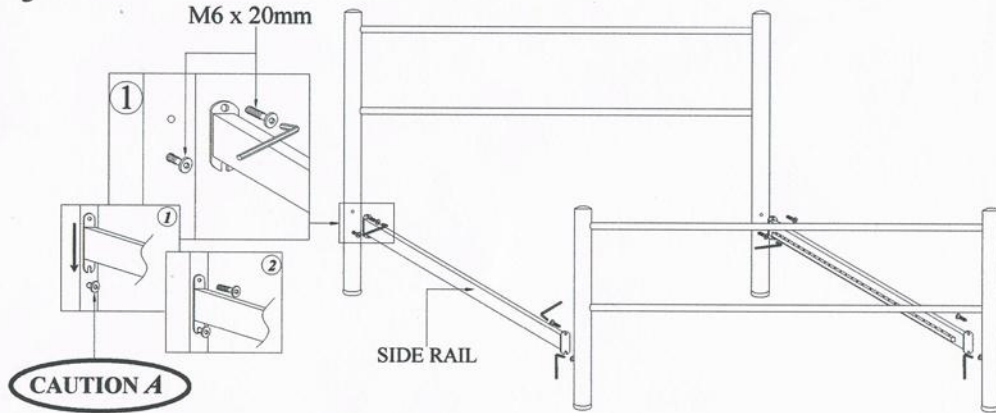

Step 3

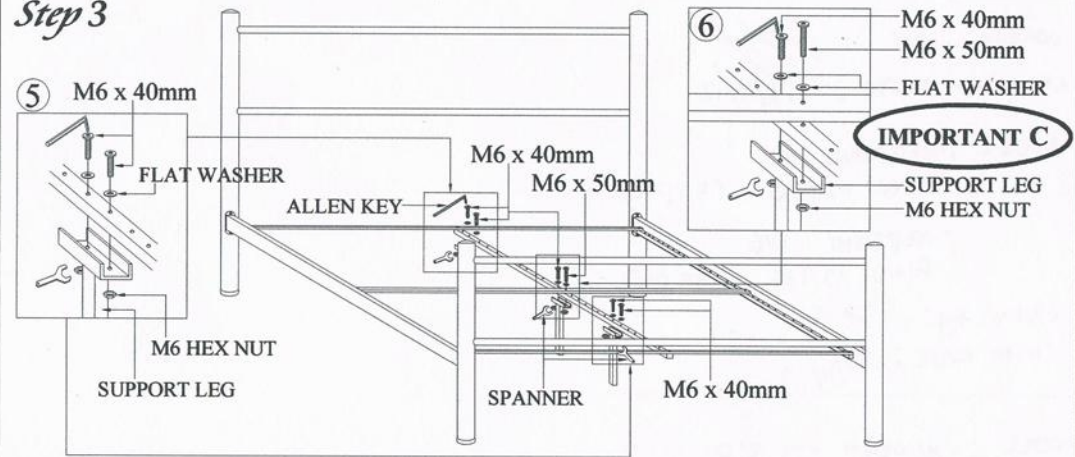

Step 2

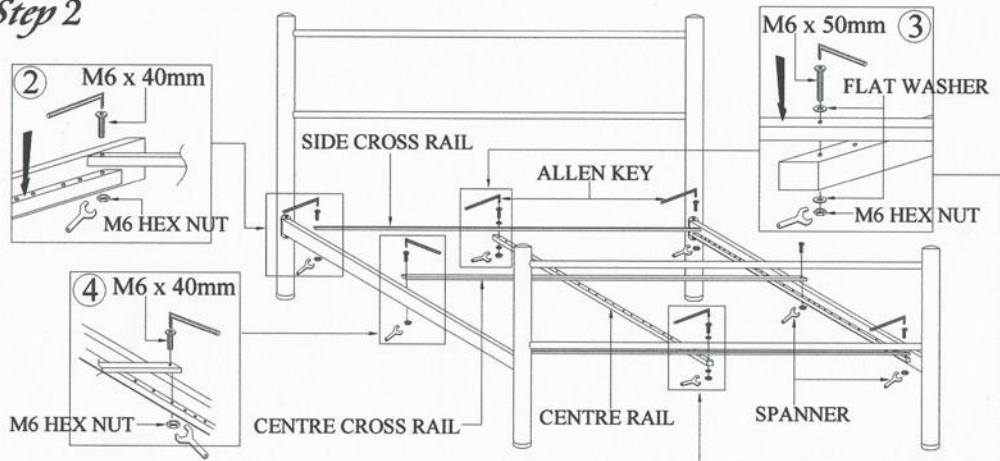

Step 4

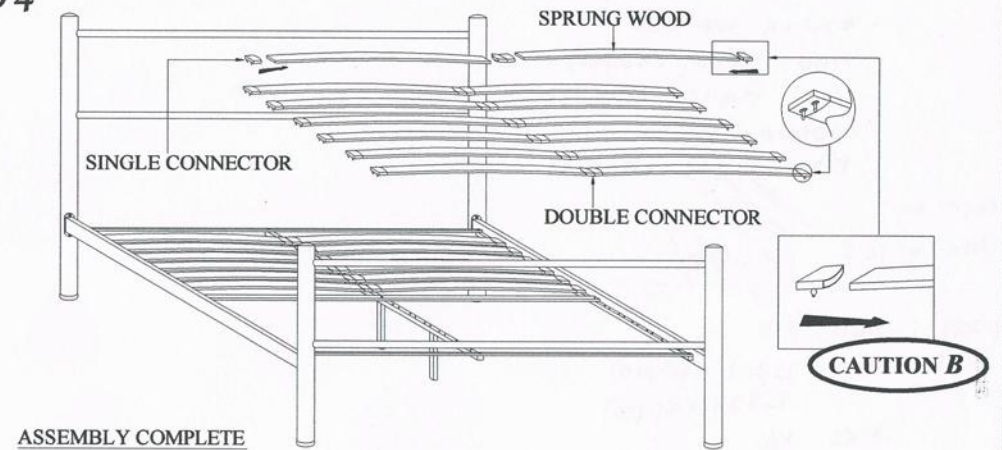

A

CAUTION!

Do not tight screw, left around 5mm before completely assembled.

C

IMPORTANT!

*Make sure support leg is straight when screw is fully tighten, if not please do adjustment
*When move the bed make sure the bed is fully lifted, if not the support will not be straight

B

CAUTION!

Make sure sprung wood is fully push tightly into single connector, if not by slowly knock single connector until tight into sprung wood.

IMPORTANT!

*Tighten all screw and complete product as shown
*Ensure cross rails are located in the side rails before placing the mattress on the bed frame"

ATTENTION!

- o Wipe clean using a soft damp cloth followed by a dry cloth.
- o Do not use abrasives or cleaning products which may contain ammonia or solvents.
- o Take care when handling or moving the furniture. Careless handling can damage wooden furniture, try to lift rather than drag.



CARE INSTRUCTIONS

- Wipe clean using a soft damp cloth followed by a dry cloth.
- Do not use abrasives or cleaning products which may contain ammonia or solvents.
- Take care when handling or moving the furniture. Careless handling can damage furniture, try to lift rather than drag.